

PASS-THRU/NON PASS-THRU EVIDENCE LOCKERS

LOCKERS

Tiffin Metal Products has been manufacturing Sentinel Security Lockers for over 30 years. They are used throughout the world wherever controlled security is required. You will find our lockers in areas of police evidence transfer, evidence storage, crime scene investigations, forensic evidence, or in postal service. When teamed with our Refrigerated Lockers you have a complete system.

FEATURES:

- Lift latch keyless lock
- Keyed lock option with key drop
- 36"W x 24"D x 82"H (w/4" base)
- 16 gauge cold rolled steel
- 4" attached base
- Refrigerated models available
- Powder coated finish
- Continuous 16 gauge piano hinges
- 34 standard modules (4 modules available in 18" width)
- Single rear door allows access to all compartments from control side (Pass-Thru models only)
- Passback option w/digital locking



12AA PASS-THRU
(Shown with lift latch keyless lock)

GSA Advantage![®]



Manufacturing Quality Metal Products Since 1903
Tiffin Metal Products
450 Wall Street
Tiffin, Ohio, 44883

Phone: 800-537-0983
Fax: 419-447-5175

email: sentinellockers@tiffinmetal.com
www.tiffinmetal.com
www.sentinellockers.com

SAMPLE ARRANGEMENTS



1801AA



1802AA



1802AB



1808AA

All lockers are 24"D x 82"H including a 4" attached base.

Sample 18"W modules are shown at left.

All other sample module configurations are 36"W.

UNIT DIMENSIONS

DOOR	WIDTH	LENGTH
B	10 ³ / ₁₆ "	9 ¹ / ₈ "
FF	33 ¹ / ₈ "	37 ³ / ₈ "
H	10 ³ / ₁₆ "	37 ³ / ₈ "
HF	9 ³ / ₁₆ "	37 ³ / ₈ "
HH	21 ¹ / ₈ "	37 ³ / ₈ "
J	10 ³ / ₁₆ "	18 ³ / ₁₆ "
KK	15 ⁷ / ₈ "	8 ¹ / ₈ "
L	10 ³ / ₁₆ "	15"
M	10 ³ / ₁₆ "	11 ³ / ₄ "
S	15 ⁷ / ₈ "	75 ⁷ / ₈ "
T	15 ⁷ / ₈ "	37 ³ / ₈ "
V	15 ⁷ / ₈ "	18 ³ / ₁₆ "
X	15 ⁷ / ₈ "	15"
3A	7 ³ / ₁₆ "	37 ³ / ₈ "
3B	7 ³ / ₁₆ "	18 ³ / ₁₆ "
3E	7 ³ / ₁₆ "	6 ⁵ / ₈ "
3J	10 ³ / ₁₆ "	56 ⁵ / ₈ "
3V	15 ⁷ / ₈ "	56 ⁵ / ₈ "
6A	7 ³ / ₁₆ "	59 ⁷ / ₈ "
6BB	21 ¹ / ₈ "	18 ³ / ₁₆ "
6D	7 ³ / ₁₆ "	63 ¹ / ₈ "
6F	7 ³ / ₁₆ "	9 ¹ / ₈ "
6G	10 ³ / ₁₆ "	59 ⁷ / ₈ "
6S	15 ⁷ / ₈ "	59 ⁷ / ₈ "
6X	15 ⁷ / ₈ "	9 ¹ / ₈ "
7E	7 ³ / ₁₆ "	11 ³ / ₄ "

DOOR	WIDTH	LENGTH
B	10 ³ / ₁₆ "	9 ¹ / ₈ "
FF	33 ¹ / ₈ "	37 ³ / ₈ "
H	10 ³ / ₁₆ "	37 ³ / ₈ "
HF	9 ³ / ₁₆ "	37 ³ / ₈ "
HH	21 ¹ / ₈ "	37 ³ / ₈ "
J	10 ³ / ₁₆ "	18 ³ / ₁₆ "
KK	15 ⁷ / ₈ "	8 ¹ / ₈ "
L	10 ³ / ₁₆ "	15"
M	10 ³ / ₁₆ "	11 ³ / ₄ "
S	15 ⁷ / ₈ "	75 ⁷ / ₈ "
T	15 ⁷ / ₈ "	37 ³ / ₈ "
V	15 ⁷ / ₈ "	18 ³ / ₁₆ "
X	15 ⁷ / ₈ "	15"
3A	7 ³ / ₁₆ "	37 ³ / ₈ "
3B	7 ³ / ₁₆ "	18 ³ / ₁₆ "
3E	7 ³ / ₁₆ "	6 ⁵ / ₈ "
3J	10 ³ / ₁₆ "	56 ⁵ / ₈ "
3V	15 ⁷ / ₈ "	56 ⁵ / ₈ "
6A	7 ³ / ₁₆ "	59 ⁷ / ₈ "
6BB	21 ¹ / ₈ "	18 ³ / ₁₆ "
6D	7 ³ / ₁₆ "	63 ¹ / ₈ "
6F	7 ³ / ₁₆ "	9 ¹ / ₈ "
6G	10 ³ / ₁₆ "	59 ⁷ / ₈ "
6S	15 ⁷ / ₈ "	59 ⁷ / ₈ "
6X	15 ⁷ / ₈ "	9 ¹ / ₈ "
7E	7 ³ / ₁₆ "	11 ³ / ₄ "



02AA



02AB

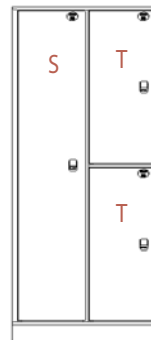

03AA

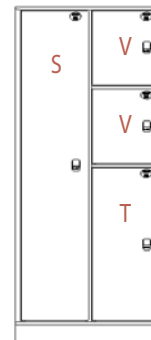

04AA



04AB



04AC

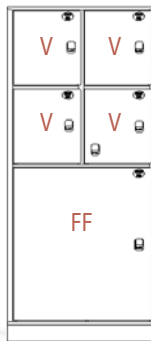

05AA

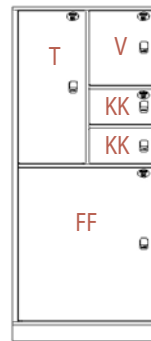

05AB

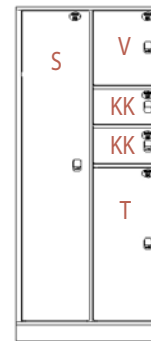

05AC

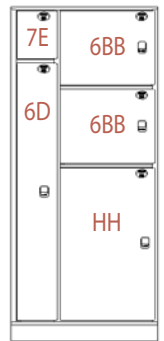

05AD

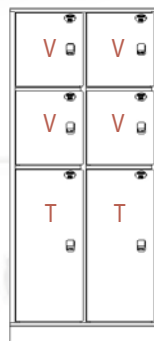

06AA



06AC

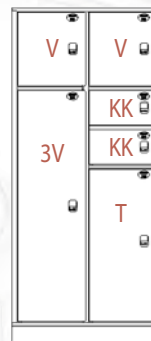

06AD



07AA

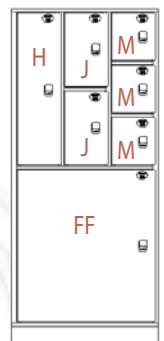

07AB



Manufacturing Quality Metal Products Since 1903

Tiffin Metal Products
450 Wall Street
Tiffin, Ohio, 44883

Phone: 800-537-0983
Fax: 419-447-5175

email: sentinellockers@tiffinmetal.com
www.tiffinmetal.com
www.sentinellockers.com

SAMPLE ARRANGEMENTS

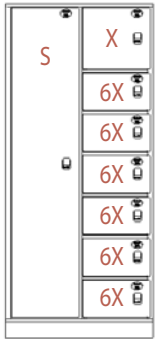

08AA

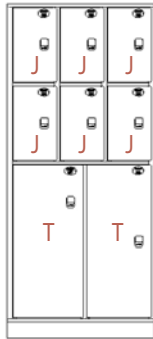

08AB



08AC

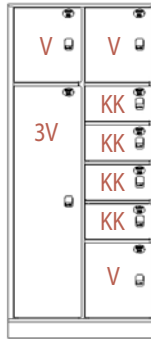

08AD

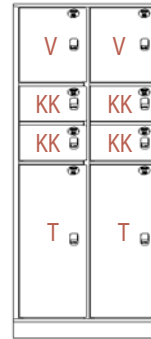

08AE

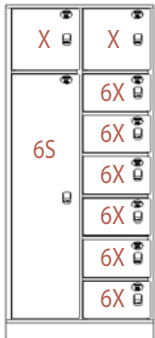

09AA

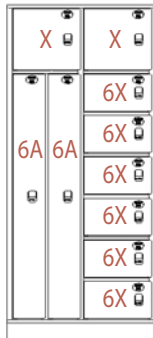

10AA

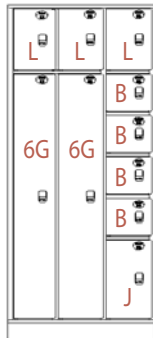

10AB



11AA

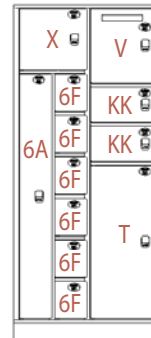

12AA

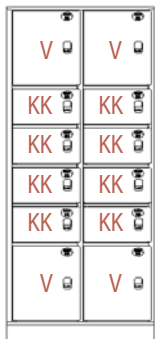

12AB

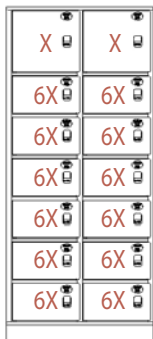

14AA

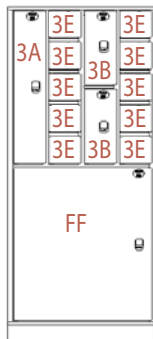

14AB

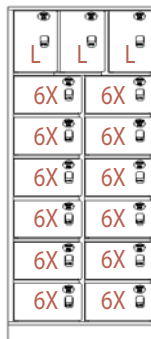

15AA



24AA



12AA Module Configuration

UNIT DIMENSIONS

	DOOR WIDTH	LENGTH
B	10 ³ / ₁₆ "	9 ¹ / ₈ "
FF	33 ³ / ₈ "	37 ³ / ₈ "
H	10 ³ / ₁₆ "	37 ³ / ₈ "
HF	9 ³ / ₁₆ "	37 ³ / ₈ "
HH	21 ⁵ / ₈ "	37 ³ / ₈ "
J	10 ³ / ₁₆ "	18 ³ / ₁₆ "
KK	15 ⁷ / ₈ "	8 ¹ / ₈ "
L	10 ³ / ₁₆ "	15"
M	10 ³ / ₁₆ "	11 ³ / ₄ "
S	15 ⁷ / ₈ "	75 ⁷ / ₈ "
T	15 ⁷ / ₈ "	37 ³ / ₈ "
V	15 ⁷ / ₈ "	18 ³ / ₁₆ "
X	15 ⁷ / ₈ "	15"
3A	7 ³ / ₁₆ "	37 ³ / ₈ "
3B	7 ³ / ₁₆ "	18 ³ / ₁₆ "
3E	7 ³ / ₁₆ "	6 ⁵ / ₈ "
3J	10 ³ / ₁₆ "	56 ⁵ / ₈ "
3V	15 ⁷ / ₈ "	56 ⁵ / ₈ "
6A	7 ³ / ₁₆ "	59 ⁷ / ₈ "
6BB	21 ⁵ / ₈ "	18 ³ / ₁₆ "
6D	7 ³ / ₁₆ "	63 ¹ / ₈ "
6F	7 ³ / ₁₆ "	9 ¹ / ₈ "
6G	10 ³ / ₁₆ "	59 ⁷ / ₈ "
6S	15 ⁷ / ₈ "	59 ⁷ / ₈ "
6X	15 ⁷ / ₈ "	9 ¹ / ₈ "
7E	7 ³ / ₁₆ "	11 ³ / ₄ "



ERF82

May be used to replace any door marked "FF"



ERF3642



ERF42

Refrigerated Evidence Lockers
Various interior inserts available
(See reverse)



Manufacturing Quality Metal Products Since 1903
Tiffin Metal Products
450 Wall Street
Tiffin, Ohio, 44883

Phone: 800-537-0983
Fax: 419-447-5175

email: sentinellockers@tiffinmetal.com
www.tiffinmetal.com
www.sentinellockers.com

REFRIGERATED EVIDENCE LOCKER CONFIGURATIONS



INSIDE VIEW - 82" HIGH MODEL

Overall size: 36" W x 24" D x 82" H (with Base)

Power requirements: 115 VAC, 60 Hz, dedicated 15 amp circuit (shown with 14 door special insert)

12 DOOR INSERT

15 DOOR INSERT

18 DOOR INSERT

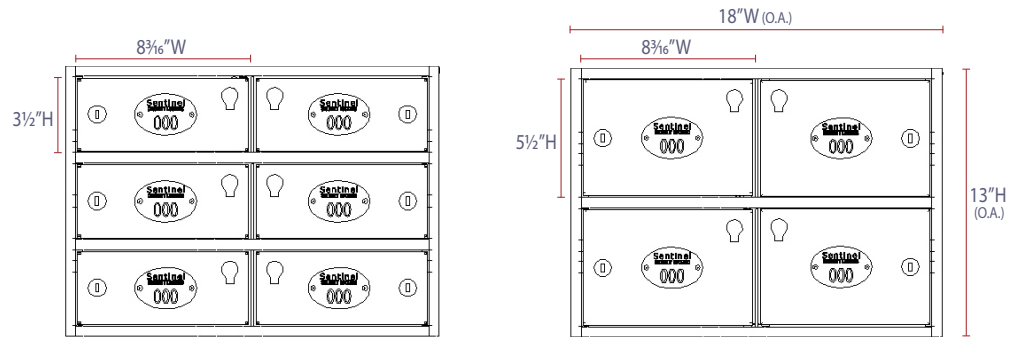

INSIDE VIEW - 42 1/2" HIGH MODEL

Overall size: 24" W x 24" D x 42 1/2" H

Power requirements: 115 VAC, 60 Hz, dedicated 15 amp circuit (shown with 6 door regular insert)

6 DOOR REGULAR INSERT

4 DOOR REGULAR INSERT

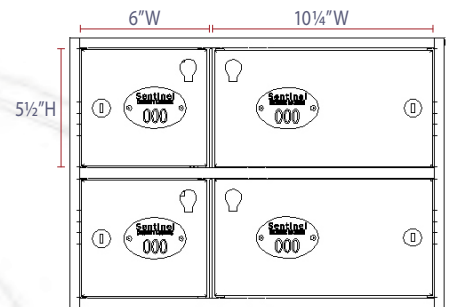
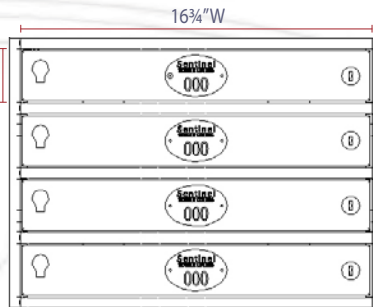

4 DOOR HORIZONTAL INSERT

4 DOOR IRREGULAR INSERT



Manufacturing Quality Metal Products Since 1903

Tiffin Metal Products
450 Wall Street
Tiffin, Ohio, 44883

Phone: 800-537-0983
Fax: 419-447-5175

email: sentinellockers@tiffinmetal.com
www.tiffinmetal.com
www.sentinellockers.com