

Side-To-Side™

GSA Price List

Contract No. **GS-25F-0084M**

Effective October 1, 2001, through September 30, 2006



PRICE INCREASE
EFFECTIVE 1/1/03 APPLY A 5% INCREASE
(1.05 MULTIPLIER) TO ALL LIST PRICES

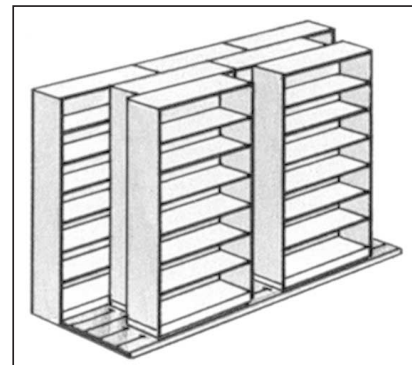
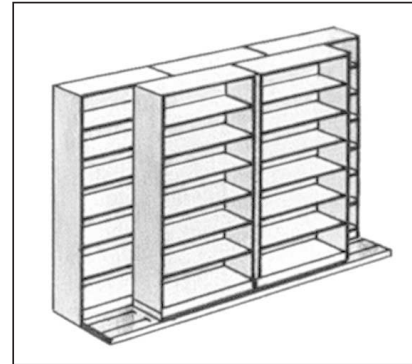
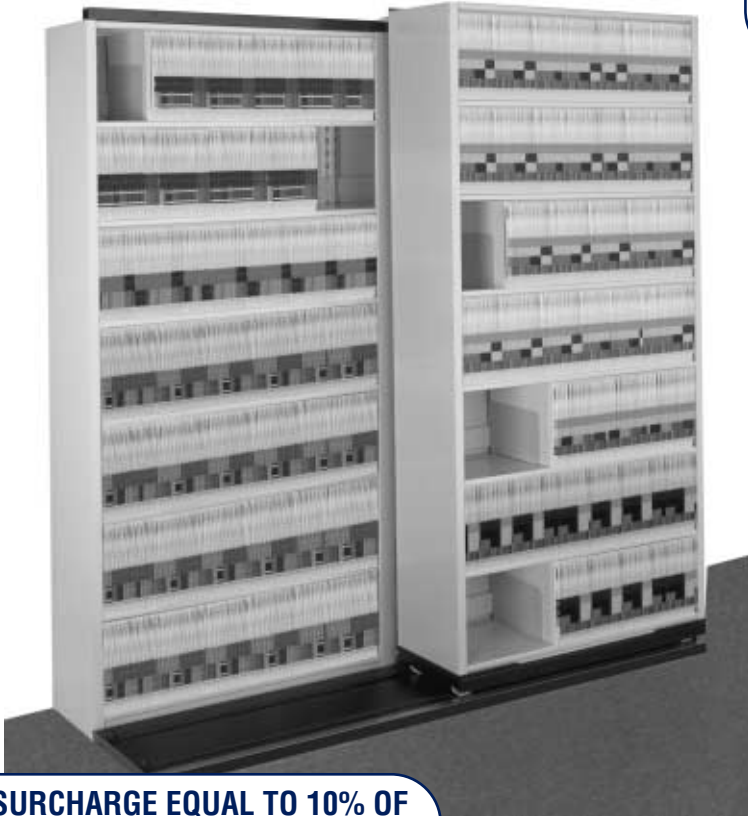

A STEEL SURCHARGE EQUAL TO 10% OF THE NET SALE PRICE MUST BE ADDED AS A LINE ITEM TO YOUR ORDER FOR ALL ITEMS IN THIS CATALOG

Authorized FSS Schedule Price List

OFFICE, IMAGING, AND DOCUMENT SOLUTIONS

FSC GROUP 36, PART IV, FSC CLASS 7460

SPECIAL ITEM NUMBER 165-205 MULTIMEDIA FILING

Includes modification 005 - December 15, 2004

RICHARDS-WILCOX, INC.

Government Sales

600 S. Lake Street

Aurora, IL 60506

Phone: 800-253-5668 ext. 4695

Facsimile: 630-897-6994

www.auroramobile.com

Business Size: Small

Federal Supply Service

U.S. General Services Administration

On-line access to contract ordering information, terms and conditions, up-to-date pricing, and the option to create an electronic delivery order are available through GSA Advantage!™, a menu-driven database system.

<http://www.GSAAdvantage.gov>

1. SPECIAL ITEM NUMBERS

#165-205 Multimedia Filing

2. MAXIMUM ORDER

\$750,000

3. MINIMUM ORDER

\$100

4. GEOGRAPHIC COVERAGE

Worldwide

5. POINT OF PRODUCTION

Richards-Wilcox, Inc.
600 South Lake Street
Aurora, Illinois 60506
(Kane County)

6. DISCOUNTS

(List Price)

\$100-\$60,000

36.2% Discount

\$60,000 up

40.2% Discount

7. PROMPT PAYMENT TERMS

Net 30 days

8. CREDIT CARD

At the option of the Government, payments for oral and written delivery orders may be made using the Government purchase card. Please provide:

- a. Card Number
- b. Expiration Date
- c. Card Holder's Name
- d. Card Holder's Phone Number
- e. Billing Address (for receipt)

9. FOREIGN ITEMS

No foreign items are incorporated in this product.

10. TIME OF DELIVERY

7-30 days ARO

11. EXPEDITED DELIVERY

Letter size Bi-Files in Black, Adobe, Off-White, Mushroom, Gray Mist or Pebble Tan

2-13 days ARO

12. F.O.B POINTS

For overseas delivery of Aurora Side-To-Side, all prices include delivery to any embarkation point within the 48 contiguous states, for transport to Federal Government installations located outside the 48 contiguous states. This includes Alaska, Hawaii, and Puerto Rico. For shipment made direct to such installations by Richards-Wilcox, Inc., actual expenses incurred for costs, insurance and freight (CIF charges) will be added to the invoice on an open market basis.

13. ORDERING ADDRESS

Richards-Wilcox, Inc.
c/o Authorized Aurora Side-To-Side Dealer
600 South Lake Street
Aurora, IL 60506-5565

14. PAYMENT ADDRESS

Invoice will be rendered by, and payment must be made to:
Richards-Wilcox, Inc.
35242 Eagle Way
Chicago, IL 60678-1352

15. WARRANTY

All Aurora Side-To-Sides are warranted against defective workmanship and materials for two years after installation by an Authorized Aurora Side-To-Side Dealer.

16. EXPORT PACKING CHARGES

Corrugated cartons, steel-banded to wood pallets, are regularly used for domestic and overseas shipment.

Special packaging (e.g. exterior crating) will be quoted on request. Provide detailed specification for the particular order.

17. TERMS AND CONDITIONS OF INSTALLATION

Aurora Side-To-Side is shipped "KD", that is, unassembled. An illustrated installation manual is included. Assembly is required at the job site.

The assembly (pre-installation storage, space layout, inside delivery, moving/disassembly and reconstruction of existing units, file conversions and/or media transfer, temporary storage of media, installation, installation of floor anchors, leveling, trash removal and clean up, consultation, instruction and miscellaneous installation related services as required by the Government) is available at additional cost from your local Authorized Aurora Side-To-Side Files Dealer. This service is provided "Open Market." Ask your dealer for a quotation.

You can prepare a single purchase order to cover both equipment and open market installation. Equipment may be billed separate from open market installation related services.

18. MISCELLANEOUS INFORMATION

Federal ID: 36-4069924
Cage Code: 50798

19. CENTRAL CONTRACTOR REGISTRY

Richards-Wilcox, Inc. maintains and updates our registration in this database under Duns number 938853769

36" WIDE COMPLETE 2 ROW LATERAL FILING SYSTEM WITH AURORA SHELVING

ITEM NUMBER	W.	O.D.*	H.	L.F.I.**	WEIGHT	LIST
LM361276-0021	72"	x 26.5"	x 80"	756	454	\$1,440.00
LM361576-0021	72"	x 32.5"	x 80"	756	505	\$1,560.00
LM361288-0021	72"	x 26.5"	x 92"	864	503	\$1,630.00
LM361588-0021	72"	x 32.5"	x 92"	864	557	\$1,675.00
ITEM NUMBER	W.	O.D.*	H.	L.F.I.**	WEIGHT	LIST
LM361276-0032	108"	x 26.5"	x 80"	1260	746	\$2,360.00
LM361576-0032	108"	x 32.5"	x 80"	1260	829	\$2,565.00
LM361288-0032	108"	x 26.5"	x 92"	1440	828	\$2,620.00
LM361588-0032	108"	x 32.5"	x 92"	1440	916	\$2,750.00
ITEM NUMBER	W.	O.D.*	H.	L.F.I.**	WEIGHT	LIST
LM361276-0043	144"	x 26.5"	x 80"	1764	949	\$3,290.00
LM361576-0043	144"	x 32.5"	x 80"	1764	1154	\$3,570.00
LM361288-0043	144"	x 26.5"	x 92"	2016	1152	\$3,710.00
LM261588-0043	144"	x 32.5"	x 92"	2016	1274	\$3,825.00
ITEM NUMBER	W.	O.D.*	H.	L.F.I.**	WEIGHT	LIST
LM361276-0054	180"	x 26.5"	x 80"	2268	1241	\$4,225.00
LM361576-0054	180"	x 32.5"	x 80"	2268	1478	\$4,575.00
LM361288-0054	180"	x 26.5"	x 92"	2592	1477	\$4,605.00
LM361588-0054	180"	x 32.5"	x 92"	2592	1633	\$4,905.00
ITEM NUMBER	W.	O.D.*	H.	L.F.I.**	WEIGHT	LIST
LM361276-0065	216"	x 26.5"	x 80"	2772	1534	\$5,155.00
LM361576-0065	216"	x 32.5"	x 80"	2772	1803	\$5,575.00
LM361288-0065	216"	x 26.5"	x 92"	3168	1801	\$5,595.00
LM361588-0065	216"	x 32.5"	x 92"	3168	1991	\$5,885.00
ITEM NUMBER	W.	O.D.*	H.	L.F.I.**	WEIGHT	LIST
LM361276-0076	252"	x 26.5"	x 80"	3276	1826	\$6,085.00
LM361576-0076	252"	x 32.5"	x 80"	3276	2127	\$6,590.00
LM361288-0076	252"	x 26.5"	x 92"	3744	2126	\$6,785.00
LM361588-0076	252"	x 32.5"	x 92"	3744	2350	\$7,065.00

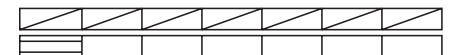
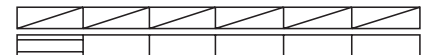
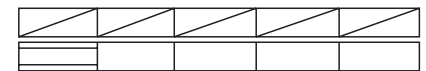
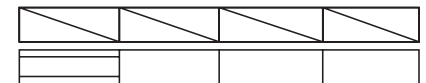
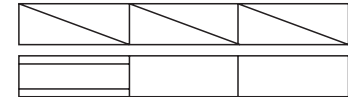
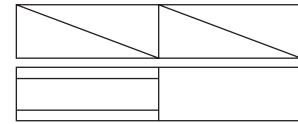

* O.D. = OVERALL DEPTH
 ** L.F.I. = LINEAR FILING INCHES

Shelving does not include file dividers. See page 15 for more information.

36" WIDE COMPLETE 3 ROW LATERAL FILING SYSTEM WITH AURORA SHELVING

ITEM NUMBER	W.	O.D.*	H.	L.F.I.**	WEIGHT	LIST
LM361276-00211	72"	x 41"	x 82"	1008	675	\$2,240.00
LM361576-00211	72"	x 50"	x 82"	1008	741	\$2,415.00
LM361288-00211	72"	x 41"	x 94"	1152	742	\$2,365.00
LM361588-00211	72"	x 50"	x 94"	1152	808	\$2,565.00
ITEM NUMBER	W.	O.D.*	H.	L.F.I.**	WEIGHT	LIST
LM361276-00322	108"	x 41"	x 82"	1260	1159	\$3,855.00
LM361576-00322	108"	x 50"	x 82"	1260	1273	\$4,165.00
LM361288-00322	108"	x 41"	x 94"	1440	1275	\$4,075.00
LM361588-00322	108"	x 50"	x 94"	1440	1396	\$4,425.00
ITEM NUMBER	W.	O.D.*	H.	L.F.I.**	WEIGHT	LIST
LM361276-00433	144"	x 41"	x 82"	2520	1642	\$5,470.00
LM361576-00433	144"	x 50"	x 82"	2520	1804	\$5,910.00
LM361288-00433	144"	x 41"	x 94"	2880	1808	\$5,780.00
LM261588-00433	144"	x 50"	x 94"	2880	1980	\$6,280.00
ITEM NUMBER	W.	O.D.*	H.	L.F.I.**	WEIGHT	LIST
LM361276-00544	180"	x 41"	x 82"	3276	2125	\$7,085.00
LM361576-00544	180"	x 50"	x 82"	3276	2335	\$7,660.00
LM361288-00544	180"	x 41"	x 94"	3744	2341	\$7,490.00
LM361588-00544	180"	x 50"	x 94"	3744	2564	\$8,140.00
ITEM NUMBER	W.	O.D.*	H.	L.F.I.**	WEIGHT	LIST
LM361276-00655	216"	x 41"	x 82"	4032	2608	\$8,700.00
LM361576-00655	216"	x 50"	x 82"	4032	2873	\$9,400.00
LM361288-00655	216"	x 41"	x 94"	4608	2866	\$9,195.00
LM361588-00655	216"	x 50"	x 94"	4608	3147	\$9,995.00
ITEM NUMBER	W.	O.D.*	H.	L.F.I.**	WEIGHT	LIST
LM361276-00766	252"	x 41"	x 82"	4788	3092	\$10,315.00
LM361576-00766	252"	x 50"	x 82"	4788	3398	\$11,150.00
LM361288-00766	252"	x 41"	x 94"	5472	3406	\$10,905.00
LM361588-00766	252"	x 50"	x 94"	5472	3731	\$11,850.00

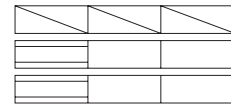
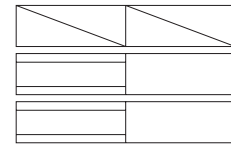

* O.D. = OVERALL DEPTH
 ** L.F.I. = LINEAR FILING INCHES

Shelving does not include file dividers. See page 15 for more information.

42" WIDE COMPLETE 2 ROW LATERAL FILING SYSTEM WITH AURORA SHELVING

ITEM NUMBER	W.	O.D.*	H.	L.F.I.**	WEIGHT	LIST
LM421276-0021	84"	x 26.5"	x 80"	882	565	\$1,685.00
LM421576-0021	84"	x 32.5"	x 80"	882	603	\$1,790.00
LM421288-0021	84"	x 26.5"	x 92"	1008	624	\$1,800.00
LM421588-0021	84"	x 32.5"	x 92"	1008	671	\$1,920.00
ITEM NUMBER	W.	O.D.*	H.	L.F.I.**	WEIGHT	LIST
LM421276-0032	126"	x 26.5"	x 80"	1470	984	\$2,780.00
LM421576-0032	126"	x 32.5"	x 80"	1470	977	\$2,940.00
LM421288-0032	126"	x 26.5"	x 92"	1680	1027	\$2,950.00
LM421588-0032	126"	x 32.5"	x 92"	1680	1104	\$3,180.00
ITEM NUMBER	W.	O.D.*	H.	L.F.I.**	WEIGHT	LIST
LM421276-0043	168"	x 26.5"	x 80"	2058	1300	\$3,875.00
LM421576-0043	168"	x 32.5"	x 80"	2058	1381	\$4,090.00
LM421288-0043	168"	x 26.5"	x 92"	2352	1431	\$4,115.00
LM421588-0043	168"	x 32.5"	x 92"	2352	1537	\$4,390.00
ITEM NUMBER	W.	O.D.*	H.	L.F.I.**	WEIGHT	LIST
LM421276-0054	210"	x 26.5"	x 80"	2646	1668	\$4,970.00
LM421576-0054	210"	x 32.5"	x 80"	2646	1770	\$5,245.00
LM421288-0054	210"	x 26.5"	x 92"	3024	1834	\$5,275.00
LM421588-0054	210"	x 32.5"	x 92"	3024	1970	\$5,560.00
ITEM NUMBER	W.	O.D.*	H.	L.F.I.**	WEIGHT	LIST
LM421276-0065	252"	x 26.5"	x 80"	3234	2035	\$6,065.00
LM421576-0065	252"	x 32.5"	x 80"	3234	2159	\$6,340.00
LM421288-0065	252"	x 26.5"	x 92"	3696	2238	\$6,435.00
LM421588-0065	252"	x 32.5"	x 92"	3696	2403	\$6,800.00
ITEM NUMBER	W.	O.D.*	H.	L.F.I.**	WEIGHT	LIST
LM421276-0076	294"	x 26.5"	x 80"	3822	2403	\$6,740.00
LM421576-0076	294"	x 32.5"	x 80"	3822	2548	\$7,100.00
LM421288-0076	294"	x 26.5"	x 92"	4368	2281	\$7,600.00
LM421588-0076	294"	x 32.5"	x 92"	4368	2836	\$8,035.00

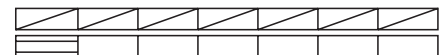
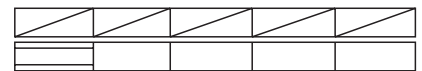
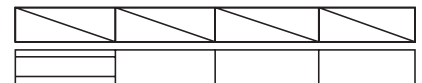
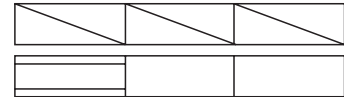
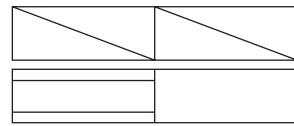

* O.D. = OVERALL DEPTH
 ** L.F.I. = LINEAR FILING INCHES

Shelving does not include file dividers. See page 15 for more information.

42" WIDE COMPLETE 3 ROW LATERAL FILING SYSTEM WITH AURORA SHELVING

ITEM NUMBER	W.	O.D.*	H.	L.F.I.**	WEIGHT	LIST
LM421276-00211	84"	x 41"	x 82"	1176	837	\$2,575.00
LM421576-00211	84"	x 50"	x 82"	1176	877	\$2,720.00
LM421288-00211	84"	x 41"	x 94"	1344	912	\$2,710.00
LM421588-00211	84"	x 50"	x 94"	1344	969	\$2,895.00
ITEM NUMBER	W.	O.D.*	H.	L.F.I.**	WEIGHT	LIST
LM421276-00322	126"	x 41"	x 82"	2058	1432	\$4,445.00
LM421576-00322	126"	x 50"	x 82"	2058	1507	\$4,690.00
LM421288-00322	126"	x 41"	x 94"	2352	1559	\$4,680.00
LM421588-00322	126"	x 50"	x 94"	2352	1666	\$4,995.00
ITEM NUMBER	W.	O.D.*	H.	L.F.I.**	WEIGHT	LIST
LM421276-00433	168"	x 41"	x 82"	2940	2032	\$6,320.00
LM421576-00433	168"	x 50"	x 82"	2940	2136	\$6,665.00
LM421288-00433	168"	x 41"	x 94"	3360	2212	\$6,645.00
LM421588-00433	168"	x 50"	x 94"	3360	2363	\$7,095.00
ITEM NUMBER	W.	O.D.*	H.	L.F.I.**	WEIGHT	LIST
LM421276-00544	210"	x 41"	x 82"	3822	2633	\$8,190.00
LM421576-00544	210"	x 50"	x 82"	3822	2766	\$8,630.00
LM421288-00544	210"	x 41"	x 94"	4368	2866	\$8,610.00
LM421588-00544	210"	x 50"	x 94"	4368	3061	\$9,195.00
ITEM NUMBER	W.	O.D.*	H.	L.F.I.**	WEIGHT	LIST
LM421276-00655	252"	x 41"	x 82"	4704	3234	\$10,055.00
LM421576-00655	252"	x 50"	x 82"	4704	3396	\$10,600.00
LM421288-00655	252"	x 41"	x 94"	5376	3519	\$10,575.00
LM421588-00655	252"	x 50"	x 94"	5376	3758	\$11,290.00
ITEM NUMBER	W.	O.D.*	H.	L.F.I.**	WEIGHT	LIST
LM421276-00766	294"	x 41"	x 82"	5586	3835	\$11,925.00
LM421576-00766	294"	x 50"	x 82"	5586	4026	\$12,570.00
LM421288-00766	294"	x 41"	x 94"	6384	4172	\$12,545.00
LM421588-00766	294"	x 50"	x 94"	6384	4455	\$13,390.00

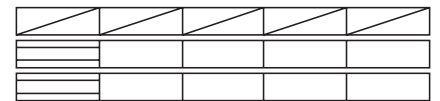
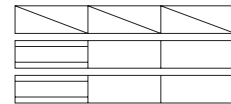
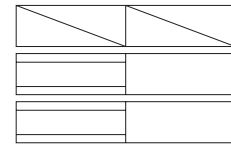

* O.D. = OVERALL DEPTH
 ** L.F.I. = LINEAR FILING INCHES

Shelving does not include file dividers. See page 15 for more information.

48" WIDE COMPLETE 2 ROW LATERAL FILING SYSTEM WITH AURORA SHELVING

ITEM NUMBER	W.	O.D.*	H.	L.F.I.**	WEIGHT	LIST
LM481276-0021	96"	x 26.5	x 80"	1008	627	\$1,805.00
LM481576-0021	96"	x 32.5	x 80"	1008	676	\$1,930.00
LM481288-0021	96"	x 26.5	x 92"	1152	700	\$1,940.00
LM481588-0021	96"	x 32.5	x 92"	1152	750	\$2,070.00
ITEM NUMBER	W.	O.D.*	H.	L.F.I.**	WEIGHT	LIST
LM481276-0032	144"	x 26.5	x 80"	1680	1033	\$2,980.00
LM481576-0032	144"	x 32.5	x 80"	1680	1113	\$3,175.00
LM481288-0032	144"	x 26.5	x 92"	1920	1154	\$3,190.00
LM841588-0032	144"	x 32.5	x 92"	1920	1236	\$3,415.00
ITEM NUMBER	W.	O.D.*	H.	L.F.I.**	WEIGHT	LIST
LM481276-0043	192"	x 26.5	x 80"	2352	1439	\$4,155.00
LM481576-0043	192"	x 32.5	x 80"	2352	1550	\$4,500.00
LM481288-0043	192"	x 26.5	x 92"	2688	1607	\$4,525.00
LM481588-0043	192"	x 32.5	x 92"	2688	1721	\$4,730.00
ITEM NUMBER	W.	O.D.*	H.	L.F.I.**	WEIGHT	LIST
LM481276-0054	240"	x 26.5	x 80"	3024	1845	\$5,330.00
LM481576-0054	240"	x 32.5	x 80"	3024	1987	\$5,670.00
LM481288-0054	240"	x 26.5	x 92"	3456	2061	\$5,710.00
LM481588-0054	240"	x 32.5	x 92"	3456	2207	\$6,020.00
ITEM NUMBER	W.	O.D.*	H.	L.F.I.**	WEIGHT	LIST
LM481276-0065	288"	x 26.5	x 80"	3696	2251	\$6,505.00
LM481576-0065	288"	x 32.5	x 80"	3696	2514	\$6,920.00
LM481288-0065	288"	x 26.5	x 92"	4224	2424	\$6,930.00
LM481588-0065	288"	x 32.5	x 92"	4224	2692	\$7,365.00
ITEM NUMBER	W.	O.D.*	H.	L.F.I.**	WEIGHT	LIST
LM481276-0076	336"	x 26.5	x 80"	4368	2657	\$7,680.00
LM481576-0076	336"	x 32.5	x 80"	4368	2861	\$8,165.00
LM481288-0076	336"	x 26.5	x 92"	4992	2968	\$8,250.00
LM481588-0076	336"	x 32.5	x 92"	4992	3178	\$8,705.00

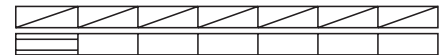
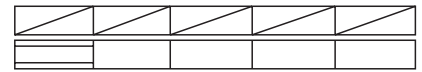
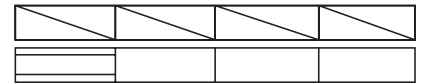
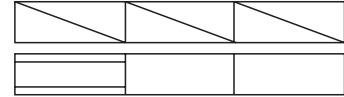
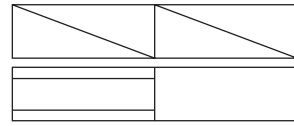

* O.D. = OVERALL DEPTH
 ** L.F.I. = LINEAR FILING INCHES

Shelving does not include file dividers. See page 15 for more information.

48" WIDE COMPLETE 3 ROW LATERAL FILING SYSTEM WITH AURORA SHELVING

ITEM NUMBER	W.	O.D.*	H.	L.F.I.**	WEIGHT	LIST
LM481276-00211	96"	x 41"	x 80"	1344	913	\$2,480.00
LM481576-00211	96"	x 50"	x 80"	1344	979	\$2,660.00
LM481288-00211	96"	x 41"	x 92"	1536	1011	\$2,620.00
LM481588-00211	96"	x 50"	x 92"	1536	1079	\$2,820.00
ITEM NUMBER	W.	O.D.*	H.	L.F.I.**	WEIGHT	LIST
LM481276-00322	144"	x 41"	x 80"	2352	1572	\$4,270.00
LM481576-00322	144"	x 50"	x 80"	2352	1683	\$4,570.00
LM481288-00322	144"	x 41"	x 92"	2688	1742	\$4,510.00
LM481588-00322	144"	x 50"	x 92"	2688	1857	\$4,850.00
ITEM NUMBER	W.	O.D.*	H.	L.F.I.**	WEIGHT	LIST
LM481276-00433	196"	x 41"	x 80"	3360	2230	\$6,055.00
LM481576-00433	196"	x 50"	x 80"	3360	2230	\$6,405.00
LM481288-00433	196"	x 41"	x 92"	3840	2473	\$6,475.00
LM481588-00433	196"	x 50"	x 92"	3840	2635	\$6,875.00
ITEM NUMBER	W.	O.D.*	H.	L.F.I.**	WEIGHT	LIST
LM481276-00544	244"	x 41"	x 80"	4368	2889	\$7,585.00
LM481576-00544	244"	x 50"	x 80"	4368	3090	\$8,390.00
LM481288-00544	244"	x 41"	x 92"	4992	3204	\$8,290.00
LM481588-00544	244"	x 50"	x 92"	4992	3413	\$8,905.00
ITEM NUMBER	W.	O.D.*	H.	L.F.I.**	WEIGHT	LIST
LM481276-00655	292"	x 41"	x 80"	5376	3547	\$9,630.00
LM481576-00655	292"	x 50"	x 80"	5376	3793	\$10,300.00
LM481288-00655	292"	x 41"	x 92"	6144	3934	\$10,180.00
LM481588-00655	292"	x 50"	x 92"	6144	4190	\$10,935.00
ITEM NUMBER	W.	O.D.*	H.	L.F.I.**	WEIGHT	LIST
LM481276-00766	340"	x 41"	x 80"	6384	4206	\$11,420.00
LM481576-00766	340"	x 50"	x 80"	6384	4497	\$12,210.00
LM481288-00766	340"	x 41"	x 92"	7296	4665	\$12,070.00
LM481588-00766	340"	x 50"	x 92"	7296	4968	\$12,965.00

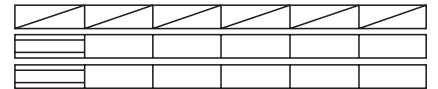
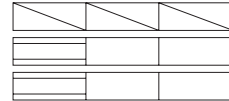
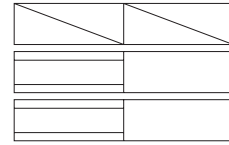

* O.D. = OVERALL DEPTH
 ** L.F.I. = LINEAR FILING INCHES

Shelving does not include file dividers. See page 15 for more information.

36" WIDE 1 ROW ADD-ON LATERAL FILING SYSTEM WITH AURORA SHELVING

Add-On Lateral Filing Systems Can Only Be Used With Existing Aurora Shelving

ITEM NUMBER	W.	O.D.*	H.	L.F.I.**	WEIGHT	LIST																	
LM361276-0001	72"	x 26.5	x 80"	252	210	\$935.00	<table border="1"> <tr><td colspan="4">EXISTING SHELVING</td></tr> <tr><td></td><td></td><td></td><td></td></tr> <tr><td></td><td></td><td></td><td></td></tr> <tr><td></td><td></td><td></td><td></td></tr> </table>	EXISTING SHELVING															
EXISTING SHELVING																							
LM361576-0001	72"	x 32.5	x 80"	252	247	\$1,000.00																	
LM361288-0001	72"	x 26.5	x 92"	288	225	\$1,020.00																	
LM361588-0001	72"	x 32.5	x 92"	288	266	\$1,040.00																	
ITEM NUMBER	W.	O.D.*	H.	L.F.I.**	WEIGHT	LIST																	
LM361276-0002	108"	x 26.5	x 80"	504	381	\$1,625.00	<table border="1"> <tr><td colspan="4">EXISTING SHELVING</td></tr> <tr><td></td><td></td><td></td><td></td></tr> <tr><td></td><td></td><td></td><td></td></tr> <tr><td></td><td></td><td></td><td></td></tr> </table>	EXISTING SHELVING															
EXISTING SHELVING																							
LM361576-0002	108"	x 32.5	x 80"	504	452	\$1,745.00																	
LM361288-0002	108"	x 26.5	x 92"	576	410	\$1,785.00																	
LM361588-0002	108"	x 32.5	x 92"	576	489	\$1,825.00																	
ITEM NUMBER	W.	O.D.*	H.	L.F.I.**	WEIGHT	LIST																	
LM361276-0003	144"	x 26.5	x 80"	756	593	\$2,320.00	<table border="1"> <tr><td colspan="4">EXISTING SHELVING</td></tr> <tr><td></td><td></td><td></td><td></td></tr> <tr><td></td><td></td><td></td><td></td></tr> <tr><td></td><td></td><td></td><td></td></tr> </table>	EXISTING SHELVING															
EXISTING SHELVING																							
LM361576-0003	144"	x 32.5	x 80"	756	597	\$2,490.00																	
LM361288-0003	144"	x 26.5	x 92"	864	645	\$2,515.00																	
LM261588-0003	144"	x 32.5	x 92"	864	645	\$2,605.00																	
ITEM NUMBER	W.	O.D.*	H.	L.F.I.**	WEIGHT	LIST																	
LM361276-0004	180"	x 26.5	x 80"	1008	777	\$3,020.00	<table border="1"> <tr><td colspan="4">EXISTING SHELVING</td></tr> <tr><td></td><td></td><td></td><td></td></tr> <tr><td></td><td></td><td></td><td></td></tr> <tr><td></td><td></td><td></td><td></td></tr> </table>	EXISTING SHELVING															
EXISTING SHELVING																							
LM361576-0004	180"	x 32.5	x 80"	1008	861	\$3,235.00																	
LM361288-0004	180"	x 26.5	x 92"	1152	847	\$3,245.00																	
LM361588-0004	180"	x 32.5	x 92"	1152	935	\$3,390.00																	
ITEM NUMBER	W.	O.D.*	H.	L.F.I.**	WEIGHT	LIST																	
LM361276-0005	216"	x 26.5	x 80"	1260	962	\$3,715.00	<table border="1"> <tr><td colspan="4">EXISTING SHELVING</td></tr> <tr><td></td><td></td><td></td><td></td></tr> <tr><td></td><td></td><td></td><td></td></tr> <tr><td></td><td></td><td></td><td></td></tr> </table>	EXISTING SHELVING															
EXISTING SHELVING																							
LM361576-0005	216"	x 32.5	x 80"	1260	1066	\$3,975.00																	
LM361288-0005	216"	x 26.5	x 92"	1440	1050	\$4,080.00																	
LM361588-0005	216"	x 32.5	x 92"	1440	1159	\$4,180.00																	
ITEM NUMBER	W.	O.D.*	H.	L.F.I.**	WEIGHT	LIST																	
LM361276-0006	252"	x 26.5	x 80"	1512	1147	\$4,410.00	<table border="1"> <tr><td colspan="4">EXISTING SHELVING</td></tr> <tr><td></td><td></td><td></td><td></td></tr> <tr><td></td><td></td><td></td><td></td></tr> <tr><td></td><td></td><td></td><td></td></tr> </table>	EXISTING SHELVING															
EXISTING SHELVING																							
LM361576-0006	252"	x 32.5	x 80"	1512	1271	\$4,730.00																	
LM361288-0006	252"	x 26.5	x 92"	1728	1252	\$4,830.00																	
LM361588-0006	252"	x 32.5	x 92"	1728	1382	\$4,965.00																	

* O.D. = OVERALL DEPTH
 ** L.F.I. = LINEAR FILING INCHES

Shelving does not include file dividers. See page 15 for more information.

36" WIDE 2 ROW ADD-ON LATERAL FILING SYSTEM WITH AURORA SHELVING

Add-On Lateral Filing Systems Can Only Be Used With Existing Aurora Shelving

ITEM NUMBER	W.	O.D.*	H.	L.F.I.**	WEIGHT	LIST																	
LM361276-00011	72"	x 41"	x 82"	504	445	\$1,735.00	<table border="1"> <tr><td colspan="4">EXISTING SHELVING</td></tr> <tr><td></td><td></td><td></td><td></td></tr> <tr><td></td><td></td><td></td><td></td></tr> <tr><td></td><td></td><td></td><td></td></tr> </table>	EXISTING SHELVING															
EXISTING SHELVING																							
LM361576-00011	72"	x 50"	x 82"	504	484	\$1,856.00																	
LM361288-00011	72"	x 41"	x 94"	576	480	\$1,805.00																	
LM361588-00011	72"	x 50"	x 94"	576	521	\$1,935.00																	
ITEM NUMBER	W.	O.D.*	H.	L.F.I.**	WEIGHT	LIST																	
LM361276-00022	108"	x 41"	x 82"	1008	820	\$3,115.00	<table border="1"> <tr><td colspan="4">EXISTING SHELVING</td></tr> <tr><td></td><td></td><td></td><td></td></tr> <tr><td></td><td></td><td></td><td></td></tr> <tr><td></td><td></td><td></td><td></td></tr> </table>	EXISTING SHELVING															
EXISTING SHELVING																							
LM361576-00022	108"	x 50"	x 82"	1008	895	\$3,345.00																	
LM361288-00022	108"	x 41"	x 94"	1152	890	\$3,240.00																	
LM361588-00022	108"	x 50"	x 94"	1152	969	\$3,500.00																	
ITEM NUMBER	W.	O.D.*	H.	L.F.I.**	WEIGHT	LIST																	
LM361276-00033	144"	x 41"	x 82"	1512	1196	\$4,495.00	<table border="1"> <tr><td colspan="4">EXISTING SHELVING</td></tr> <tr><td></td><td></td><td></td><td></td></tr> <tr><td></td><td></td><td></td><td></td></tr> <tr><td></td><td></td><td></td><td></td></tr> </table>	EXISTING SHELVING															
EXISTING SHELVING																							
LM361576-00033	144"	x 50"	x 82"	1512	1307	\$4,835.00																	
LM361288-00033	144"	x 41"	x 94"	1728	1301	\$4,685.00																	
LM261588-00033	144"	x 50"	x 94"	1728	1418	\$5,065.00																	
ITEM NUMBER	W.	O.D.*	H.	L.F.I.**	WEIGHT	LIST																	
LM361276-00044	180"	x 41"	x 82"	2016	1571	\$5,880.00	<table border="1"> <tr><td colspan="4">EXISTING SHELVING</td></tr> <tr><td></td><td></td><td></td><td></td></tr> <tr><td></td><td></td><td></td><td></td></tr> <tr><td></td><td></td><td></td><td></td></tr> </table>	EXISTING SHELVING															
EXISTING SHELVING																							
LM361576-00044	180"	x 50"	x 82"	2016	1718	\$6,320.00																	
LM361288-00044	180"	x 41"	x 94"	2304	1711	\$6,130.00																	
LM361588-00044	180"	x 50"	x 94"	2304	1866	\$6,625.00																	
ITEM NUMBER	W.	O.D.*	H.	L.F.I.**	WEIGHT	LIST																	
LM361276-00655	216"	x 41"	x 82"	2520	1947	\$7,260.00	<table border="1"> <tr><td colspan="4">EXISTING SHELVING</td></tr> <tr><td></td><td></td><td></td><td></td></tr> <tr><td></td><td></td><td></td><td></td></tr> <tr><td></td><td></td><td></td><td></td></tr> </table>	EXISTING SHELVING															
EXISTING SHELVING																							
LM361576-00655	216"	x 50"	x 82"	2520	2130	\$7,800.00																	
LM361288-00655	216"	x 41"	x 94"	2880	2122	\$7,570.00																	
LM361588-00655	216"	x 50"	x 94"	2800	2315	\$8,190.00																	
ITEM NUMBER	W.	O.D.*	H.	L.F.I.**	WEIGHT	LIST																	
LM361276-00066	252"	x 41"	x 82"	3024	2322	\$8,640.00	<table border="1"> <tr><td colspan="4">EXISTING SHELVING</td></tr> <tr><td></td><td></td><td></td><td></td></tr> <tr><td></td><td></td><td></td><td></td></tr> <tr><td></td><td></td><td></td><td></td></tr> </table>	EXISTING SHELVING															
EXISTING SHELVING																							
LM361576-00066	252"	x 50"	x 82"	3024	2541	\$9,290.00																	
LM361288-00066	252"	x 41"	x 94"	3456	2532	\$9,015.00																	
LM361588-00066	252"	x 50"	x 94"	3456	2763	\$9,755.00																	

* O.D. = OVERALL DEPTH
 ** L.F.I. = LINEAR FILING INCHES

Shelving does not include file dividers. See page 15 for more information.

42" WIDE 1 ROW ADD-ON LATERAL FILING SYSTEM WITH AURORA SHELVING

Add-On Lateral Filing Systems Can Only Be Used With Existing Aurora Shelving

ITEM NUMBER	W.	O.D.*	H.	L.F.I.**	WEIGHT	LIST																	
LM421276-0001	84"	x 26.5	x 80"	294	270	\$1,055.00	<table border="1"> <tr><td colspan="4">EXISTING SHELVING</td></tr> <tr><td></td><td></td><td></td><td></td></tr> <tr><td></td><td></td><td></td><td></td></tr> <tr><td></td><td></td><td></td><td></td></tr> </table>	EXISTING SHELVING															
EXISTING SHELVING																							
LM421576-0001	84"	x 32.5	x 80"	294	287	\$1,120.00																	
LM421288-0001	84"	x 26.5	x 92"	336	286	\$1,130.00																	
LM421588-0001	84"	x 32.5	x 92"	336	310	\$1,165.00																	
ITEM NUMBER	W.	O.D.*	H.	L.F.I.**	WEIGHT	LIST																	
LM421276-0002	126"	x 26.5	x 80"	588	497	\$1,855.00	<table border="1"> <tr><td colspan="4">EXISTING SHELVING</td></tr> <tr><td></td><td></td><td></td><td></td></tr> <tr><td></td><td></td><td></td><td></td></tr> <tr><td></td><td></td><td></td><td></td></tr> </table>	EXISTING SHELVING															
EXISTING SHELVING																							
LM421576-0002	126"	x 32.5	x 80"	588	526	\$1,950.00																	
LM421288-0002	126"	x 26.5	x 92"	672	530	\$2,025.00																	
LM421588-0002	126"	x 32.5	x 92"	672	573	\$2,065.00																	
ITEM NUMBER	W.	O.D.*	H.	L.F.I.**	WEIGHT	LIST																	
LM421276-0003	168"	x 26.5	x 80"	882	724	\$2,655.00	<table border="1"> <tr><td colspan="4">EXISTING SHELVING</td></tr> <tr><td></td><td></td><td></td><td></td></tr> <tr><td></td><td></td><td></td><td></td></tr> <tr><td></td><td></td><td></td><td></td></tr> </table>	EXISTING SHELVING															
EXISTING SHELVING																							
LM421576-0003	168"	x 32.5	x 80"	882	766	\$2,790.00																	
LM421288-0003	168"	x 26.5	x 92"	1008	774	\$2,845.00																	
LM421588-0003	168"	x 32.5	x 92"	1008	736	\$2,925.00																	
ITEM NUMBER	W.	O.D.*	H.	L.F.I.**	WEIGHT	LIST																	
LM421276-0004	210"	x 26.5	x 80"	1176	951	\$3,455.00	<table border="1"> <tr><td colspan="4">EXISTING SHELVING</td></tr> <tr><td></td><td></td><td></td><td></td></tr> <tr><td></td><td></td><td></td><td></td></tr> <tr><td></td><td></td><td></td><td></td></tr> </table>	EXISTING SHELVING															
EXISTING SHELVING																							
LM421576-0004	210"	x 32.5	x 80"	1176	1005	\$3,615.00																	
LM421288-0004	210"	x 26.5	x 92"	1344	1017	\$3,650.00																	
LM421588-0004	210"	x 32.5	x 92"	1344	1099	\$3,740.00																	
ITEM NUMBER	W.	O.D.*	H.	L.F.I.**	WEIGHT	LIST																	
LM421276-0005	252"	x 26.5	x 80"	1470	1179	\$4,255.00	<table border="1"> <tr><td colspan="4">EXISTING SHELVING</td></tr> <tr><td></td><td></td><td></td><td></td></tr> <tr><td></td><td></td><td></td><td></td></tr> <tr><td></td><td></td><td></td><td></td></tr> </table>	EXISTING SHELVING															
EXISTING SHELVING																							
LM421576-0005	252"	x 32.5	x 80"	1470	1245	\$4,405.00																	
LM421288-0005	252"	x 26.5	x 92"	1680	1261	\$4,500.00																	
LM421588-0005	252"	x 32.5	x 92"	1680	1363	\$4,625.00																	
ITEM NUMBER	W.	O.D.*	H.	L.F.I.**	WEIGHT	LIST																	
LM421276-0006	292"	x 26.5	x 80"	1764	1406	\$4,655.00	<table border="1"> <tr><td colspan="4">EXISTING SHELVING</td></tr> <tr><td></td><td></td><td></td><td></td></tr> <tr><td></td><td></td><td></td><td></td></tr> <tr><td></td><td></td><td></td><td></td></tr> </table>	EXISTING SHELVING															
EXISTING SHELVING																							
LM421576-0006	292"	x 32.5	x 80"	1764	1484	\$5,240.00																	
LM421288-0006	292"	x 26.5	x 92"	2016	1505	\$5,340.00																	
LM421588-0006	292"	x 32.5	x 92"	2016	1626	\$5,505.00																	

* O.D. = OVERALL DEPTH
 ** L.F.I. = LINEAR FILING INCHES

Shelving does not include file dividers. See page 15 for more information.

42" WIDE 2 ROW ADD-ON LATERAL FILING SYSTEM WITH AURORA SHELVING

Add-On Lateral Filing Systems Can Only Be Used With Existing Aurora Shelving

ITEM NUMBER	W.	O.D.*	H.	L.F.I.**	WEIGHT	LIST																	
LM421276-00011	84"	x 41"	x 82"	588	535	\$1,945.00	<table border="1"> <tr><td colspan="4">EXISTING SHELVING</td></tr> <tr><td></td><td></td><td></td><td></td></tr> <tr><td></td><td></td><td></td><td></td></tr> <tr><td></td><td></td><td></td><td></td></tr> </table>	EXISTING SHELVING															
EXISTING SHELVING																							
LM421576-00011	84"	x 50"	x 82"	588	560	\$2,050.00																	
LM421288-00011	84"	x 41"	x 94"	672	568	\$2,005.00																	
LM421588-00011	84"	x 50"	x 94"	672	607	\$2,140.00																	
ITEM NUMBER	W.	O.D.*	H.	L.F.I.**	WEIGHT	LIST																	
LM421276-00022	126"	x 41"	x 82"	1176	966	\$3,525.00	<table border="1"> <tr><td colspan="4">EXISTING SHELVING</td></tr> <tr><td></td><td></td><td></td><td></td></tr> <tr><td></td><td></td><td></td><td></td></tr> <tr><td></td><td></td><td></td><td></td></tr> </table>	EXISTING SHELVING															
EXISTING SHELVING																							
LM421576-00022	126"	x 50"	x 82"	1176	1041	\$3,705.00																	
LM421288-00022	126"	x 41"	x 94"	1344	1062	\$3,640.00																	
LM421588-00022	126"	x 50"	x 94"	1344	1135	\$3,880.00																	
ITEM NUMBER	W.	O.D.*	H.	L.F.I.**	WEIGHT	LIST																	
LM421276-00033	168"	x 41"	x 82"	1764	1456	\$5,100.00	<table border="1"> <tr><td colspan="4">EXISTING SHELVING</td></tr> <tr><td></td><td></td><td></td><td></td></tr> <tr><td></td><td></td><td></td><td></td></tr> <tr><td></td><td></td><td></td><td></td></tr> </table>	EXISTING SHELVING															
EXISTING SHELVING																							
LM421576-00033	168"	x 50"	x 82"	1764	1521	\$5,345.00																	
LM421288-00033	168"	x 41"	x 94"	2016	1555	\$5,275.00																	
LM421588-00033	168"	x 50"	x 94"	2016	1662	\$5,630.00																	
ITEM NUMBER	W.	O.D.*	H.	L.F.I.**	WEIGHT	LIST																	
LM421276-00044	210"	x 41"	x 82"	2352	1962	\$6,675.00	<table border="1"> <tr><td colspan="4">EXISTING SHELVING</td></tr> <tr><td></td><td></td><td></td><td></td></tr> <tr><td></td><td></td><td></td><td></td></tr> <tr><td></td><td></td><td></td><td></td></tr> </table>	EXISTING SHELVING															
EXISTING SHELVING																							
LM421576-00044	210"	x 50"	x 82"	2352	2002	\$7,015.00																	
LM421288-00044	210"	x 41"	x 94"	2688	2049	\$6,910.00																	
LM421588-00044	210"	x 50"	x 94"	2688	2190	\$7,370.00																	
ITEM NUMBER	W.	O.D.*	H.	L.F.I.**	WEIGHT	LIST																	
LM421276-00055	252"	x 41"	x 82"	2940	2377	\$8,250.00	<table border="1"> <tr><td colspan="4">EXISTING SHELVING</td></tr> <tr><td></td><td></td><td></td><td></td></tr> <tr><td></td><td></td><td></td><td></td></tr> <tr><td></td><td></td><td></td><td></td></tr> </table>	EXISTING SHELVING															
EXISTING SHELVING																							
LM421576-00055	252"	x 50"	x 82"	2940	2482	\$8,670.00																	
LM421288-00055	252"	x 41"	x 94"	3360	2542	\$8,540.00																	
LM421588-00055	252"	x 50"	x 94"	3360	2717	\$9,115.00																	
ITEM NUMBER	W.	O.D.*	H.	L.F.I.**	WEIGHT	LIST																	
LM421276-00066	292"	x 41"	x 82"	3528	2838	\$9,820.00	<table border="1"> <tr><td colspan="4">EXISTING SHELVING</td></tr> <tr><td></td><td></td><td></td><td></td></tr> <tr><td></td><td></td><td></td><td></td></tr> <tr><td></td><td></td><td></td><td></td></tr> </table>	EXISTING SHELVING															
EXISTING SHELVING																							
LM421576-00066	292"	x 50"	x 82"	3528	2963	\$10,320.00																	
LM421288-00066	292"	x 41"	x 94"	4032	3036	\$10,175.00																	
LM421588-00066	292"	x 50"	x 94"	4032	3245	\$10,855.00																	

* O.D. = OVERALL DEPTH
 ** L.F.I. = LINEAR FILING INCHES

Shelving does not include file dividers. See page 15 for more information.

48" WIDE 1 ROW ADD-ON LATERAL FILING SYSTEM WITH AURORA SHELVING

Add-On Lateral Filing Systems Can Only Be Used With Existing Aurora Shelving

ITEM NUMBER	W.	O.D.*	H.	L.F.I.**	WEIGHT	LIST																	
LM481276-0001	96"	x 26.5	x 80"	336	293	\$1,115.00	<table border="1"> <tr><td colspan="4">EXISTING SHELVING</td></tr> <tr><td></td><td></td><td></td><td></td></tr> <tr><td></td><td></td><td></td><td></td></tr> <tr><td></td><td></td><td></td><td></td></tr> </table>	EXISTING SHELVING															
EXISTING SHELVING																							
LM481576-0001	96"	x 32.5"	x 80"	336	317	\$1,190.00																	
LM481288-0001	96"	x 26.5	x 92"	384	318	\$1,200.00																	
LM481588-0001	96"	x 32.5"	x 92"	384	343	\$1,235.00																	
ITEM NUMBER	W.	O.D.*	H.	L.F.I.**	WEIGHT	LIST																	
LM481276-0002	144"	x 26.5	x 80"	672	539	\$1,965.00	<table border="1"> <tr><td colspan="4">EXISTING SHELVING</td></tr> <tr><td></td><td></td><td></td><td></td></tr> <tr><td></td><td></td><td></td><td></td></tr> <tr><td></td><td></td><td></td><td></td></tr> </table>	EXISTING SHELVING															
EXISTING SHELVING																							
LM481576-0002	144"	x 32.5"	x 80"	672	583	\$2,045.00																	
LM481288-0002	144"	x 26.5	x 92"	768	589	\$2,090.00																	
LM481588-0002	144"	x 32.5"	x 92"	768	635	\$2,185.00																	
ITEM NUMBER	W.	O.D.*	H.	L.F.I.**	WEIGHT	LIST																	
LM481276-0003	192"	x 26.5	x 80"	1008	786	\$2,810.00	<table border="1"> <tr><td colspan="4">EXISTING SHELVING</td></tr> <tr><td></td><td></td><td></td><td></td></tr> <tr><td></td><td></td><td></td><td></td></tr> <tr><td></td><td></td><td></td><td></td></tr> </table>	EXISTING SHELVING															
EXISTING SHELVING																							
LM481576-0003	192"	x 32.5"	x 80"	1008	850	\$2,985.00																	
LM481288-0003	192"	x 26.5	x 92"	1152	860	\$2,990.00																	
LM481588-0003	192"	x 32.5"	x 92"	1152	927	\$3,110.00																	
ITEM NUMBER	W.	O.D.*	H.	L.F.I.**	WEIGHT	LIST																	
LM481276-0004	240"	x 26.5	x 80"	1344	1032	\$3,660.00	<table border="1"> <tr><td colspan="4">EXISTING SHELVING</td></tr> <tr><td></td><td></td><td></td><td></td></tr> <tr><td></td><td></td><td></td><td></td></tr> <tr><td></td><td></td><td></td><td></td></tr> </table>	EXISTING SHELVING															
EXISTING SHELVING																							
LM481576-0004	240"	x 32.5"	x 80"	1344	1116	\$3,880.00																	
LM481288-0004	240"	x 26.5	x 92"	1536	1131	\$3,930.00																	
LM481588-0004	240"	x 32.5"	x 92"	1536	1219	\$4,010.00																	
ITEM NUMBER	W.	O.D.*	H.	L.F.I.**	WEIGHT	LIST																	
LM481276-0005	288"	x 26.5	x 80"	1680	1276	\$4,510.00	<table border="1"> <tr><td colspan="4">EXISTING SHELVING</td></tr> <tr><td></td><td></td><td></td><td></td></tr> <tr><td></td><td></td><td></td><td></td></tr> <tr><td></td><td></td><td></td><td></td></tr> </table>	EXISTING SHELVING															
EXISTING SHELVING																							
LM481576-0005	288"	x 32.5"	x 80"	1680	1383	\$4,785.00																	
LM481288-0005	288"	x 26.5	x 92"	1920	1403	\$4,845.00																	
LM481588-0005	288"	x 32.5"	x 92"	1920	1512	\$4,960.00																	
ITEM NUMBER	W.	O.D.*	H.	L.F.I.**	WEIGHT	LIST																	
LM481276-0006	336"	x 26.5	x 80"	2016	1525	\$5,355.00	<table border="1"> <tr><td colspan="4">EXISTING SHELVING</td></tr> <tr><td></td><td></td><td></td><td></td></tr> <tr><td></td><td></td><td></td><td></td></tr> <tr><td></td><td></td><td></td><td></td></tr> </table>	EXISTING SHELVING															
EXISTING SHELVING																							
LM481576-0006	336"	x 32.5"	x 80"	2016	1649	\$5,680.00																	
LM481288-0006	336"	x 26.5	x 92"	2304	1674	\$5,780.00																	
LM481588-0006	336"	x 32.5"	x 92"	2304	1804	\$5,905.00																	

* O.D. = OVERALL DEPTH
 ** L.F.I. = LINEAR FILING INCHES

Shelving does not include file dividers. See page 15 for more information.

48" WIDE 2 ROW ADD-ON LATERAL FILING SYSTEM WITH AURORA SHELVING

Add-on Lateral Filing Systems Can Only Be Used With Existing Aurora Shelving

ITEM NUMBER	W.	O.D.*	H.	L.F.I.**	WEIGHT	LIST																	
LM481276-00011	96"	x 41"	x 82 "	672	579	\$2,055.00	<table border="1"> <tr><td colspan="4">EXISTING SHELVING</td></tr> <tr><td></td><td></td><td></td><td></td></tr> <tr><td></td><td></td><td></td><td></td></tr> <tr><td></td><td></td><td></td><td></td></tr> </table>	EXISTING SHELVING															
EXISTING SHELVING																							
LM481576-00011	96"	x 50"	x 82"	672	620	\$2,145.00																	
LM481288-00011	96"	x 41"	x 94"	768	629	\$2,185.00																	
LM481588-00011	96"	x 50"	x 94"	768	672	\$2,285.00																	
ITEM NUMBER	W.	O.D.*	H.	L.F.I.**	WEIGHT	LIST																	
LM481276-00022	144"	x 41"	x 82 "	1344	1078	\$3,720.00	<table border="1"> <tr><td colspan="4">EXISTING SHELVING</td></tr> <tr><td></td><td></td><td></td><td></td></tr> <tr><td></td><td></td><td></td><td></td></tr> <tr><td></td><td></td><td></td><td></td></tr> </table>	EXISTING SHELVING															
EXISTING SHELVING																							
LM481576-00022	144"	x 50"	x 82"	1344	1153	\$3,945.00																	
LM481288-00022	144"	x 41"	x 94"	1536	1177	\$3,885.00																	
LM481588-00022	144"	x 50"	x 94"	1536	1256	\$4,145.00																	
ITEM NUMBER	W.	O.D.*	H.	L.F.I.**	WEIGHT	LIST																	
LM481276-00033	192"	x 41"	x 82 "	2016	1577	\$5,380.00	<table border="1"> <tr><td colspan="4">EXISTING SHELVING</td></tr> <tr><td></td><td></td><td></td><td></td></tr> <tr><td></td><td></td><td></td><td></td></tr> <tr><td></td><td></td><td></td><td></td></tr> </table>	EXISTING SHELVING															
EXISTING SHELVING																							
LM481576-00033	192"	x 50"	x 82"	2016	1686	\$5,710.00																	
LM481288-00033	192"	x 41"	x 94"	2304	1726	\$5,630.00																	
LM481588-00033	192"	x 50"	x 94"	2304	1841	\$6,005.00																	
ITEM NUMBER	W.	O.D.*	H.	L.F.I.**	WEIGHT	LIST																	
LM481276-00044	240"	x 41"	x 82 "	2688	2076	\$7,040.00	<table border="1"> <tr><td colspan="4">EXISTING SHELVING</td></tr> <tr><td></td><td></td><td></td><td></td></tr> <tr><td></td><td></td><td></td><td></td></tr> <tr><td></td><td></td><td></td><td></td></tr> </table>	EXISTING SHELVING															
EXISTING SHELVING																							
LM481576-00044	240"	x 50"	x 82"	2688	2219	\$7,470.00																	
LM481288-00044	240"	x 41"	x 94"	3072	2274	\$7,380.00																	
LM481588-00044	240"	x 50"	x 94"	3072	2425	\$7,865.00																	
ITEM NUMBER	W.	O.D.*	H.	L.F.I.**	WEIGHT	LIST																	
LM481276-00055	288"	x 41"	x 82 "	3360	2575	\$8,700.00	<table border="1"> <tr><td colspan="4">EXISTING SHELVING</td></tr> <tr><td></td><td></td><td></td><td></td></tr> <tr><td></td><td></td><td></td><td></td></tr> <tr><td></td><td></td><td></td><td></td></tr> </table>	EXISTING SHELVING															
EXISTING SHELVING																							
LM481576-00055	288"	x 50"	x 82"	3360	2752	\$9,225.00																	
LM481288-00055	288"	x 41"	x 94"	3840	2823	\$9,125.00																	
LM481588-00055	288"	x 50"	x 94"	3840	3010	\$9,720.00																	
ITEM NUMBER	W.	O.D.*	H.	L.F.I.**	WEIGHT	LIST																	
LM481276-00066	336"	x 41"	x 82 "	4032	3074	\$10,365.00	<table border="1"> <tr><td colspan="4">EXISTING SHELVING</td></tr> <tr><td></td><td></td><td></td><td></td></tr> <tr><td></td><td></td><td></td><td></td></tr> <tr><td></td><td></td><td></td><td></td></tr> </table>	EXISTING SHELVING															
EXISTING SHELVING																							
LM481576-00066	336"	x 50"	x 82"	4032	3285	\$10,990.00																	
LM481288-00066	336"	x 41"	x 94"	4608	3371	\$10,870.00																	
LM481588-00066	336"	x 50"	x 94"	4608	3594	\$11,580.00																	

* O.D. = OVERALL DEPTH
 ** L.F.I. = LINEAR FILING INCHES

Shelving does not include file dividers. See page 15 for more information.

AURORA SHELVING ACCESSORIES

DIVIDERS

Part Number	Description	D. x H.	Weight (lbs.)	Price
1006FD	LETTER DIVIDERS	10" X 6"	0.75	\$ 1.90
1306FD	LEGAL DIVIDERS	13" X 6"	1	\$ 2.20

REFERENCE SHELVES

Part Number	Description	D. x H.	Weight (lbs.)	Price
3012RS-12	12" REFERENCE KIT	30" X 12"	12.5	\$ 42.85
3012RS-15	15" REFERENCE KIT	30" X 15"	12.75	\$ 42.85

SMALL PARTS

Part Number	Description			Price
WT	WALL TIE			\$ 4.90
TP	TOUCH-UP PAINT			\$ 5.80
PS	POST SHIM			\$ 0.70

Aurora Shelving on Side-To-Side™ Lateral Mobile is 22 Gauge and Includes Backs on Mobile Units Only. Consult Factory for 18 Gauge Shelving.

SIDE-TO-SIDE™ CARRIAGE AND RAIL PRICING*

BI-FILE			
Catalog Number	Description	List Price	Crated Weight
BF3009ST00	30" VIDEO/BOOK STARTER	\$ 245.00	38
BF3009AD00	30" VIDEO/BOOK ADDER	\$ 455.00	63
BF3012ST00	30" LETTER STARTER	\$ 245.00	38
BF3012AD00	30" LETTER ADDER	\$ 455.00	63
BF3015ST00	30" LEGAL STARTER	\$ 265.00	42
BF3015AD00	30" LEGAL ADDER	\$ 475.00	68
BF3018ST00	30" X-RAY/LATERAL FILE STARTER	\$ 285.00	46
BF3018AD00	30" X-RAY/LATERAL FILE ADDER	\$ 520.00	76
BF3609ST00	36" VIDEO/BOOK STARTER	\$ 245.00	38
BF3609AD00	36" VIDEO/BOOK ADDER	\$ 455.00	63
BF3612ST00	36" LETTER STARTER	\$ 245.00	38
BF3612AD00	36" LETTER ADDER	\$ 455.00	63
BF3615ST00	36" LEGAL STARTER	\$ 265.00	42
BF3615AD00	36" LEGAL ADDER	\$ 475.00	68
BF3618ST00	36" X-RAY/LATERAL FILE STARTER	\$ 285.00	46
BF3618AD00	36" X-RAY/LATERAL FILE ADDER	\$ 520.00	76
BF4209ST00	42" VIDEO/BOOK STARTER	\$ 250.00	42
BF4209AD00	42" VIDEO/BOOK ADDER	\$ 460.00	69
BF4212ST00	42" LETTER STARTER	\$ 265.00	42
BF4212AD00	42" LETTER ADDER	\$ 490.00	69
BF4215ST00	42" LEGAL STARTER	\$ 290.00	46
BF4215AD00	42" LEGAL ADDER	\$ 520.00	72
BF4218ST00	42" X-RAY/LATERAL STARTER	\$ 295.00	50
BF4218AD00	42" X-RAY/LATERAL ADDER	\$ 530.00	78
BF4809ST00	48" VIDEO/BOOK STARTER	\$ 255.00	46
BF4809AD00	48" VIDEO/BOOK ADDER	\$ 465.00	75
BF4812ST00	48" LETTER STARTER	\$ 280.00	46
BF4812AD00	48" LETTER ADDER	\$ 520.00	75
BF4815ST00	48" LEGAL STARTER	\$ 310.00	50
BF4815AD00	48" LEGAL ADDER	\$ 550.00	81
BF4818ST00	48" X-RAY/LATERAL STARTER	\$ 315.00	56
BF4818AD00	48" X-RAY/LATERAL ADDER	\$ 540.00	86

*Aurora Shelving is not included in above pricing.

SIDE-TO-SIDE™ CARRIAGE AND RAIL PRICING*

TRI-FILE			
Catalog Number	Description	List Price	Crated Weight
TF3009ST00	30" VIDEO/BOOK STARTER	\$ 425.00	38
TF3009AD00	30" VIDEO/BOOK ADDER	\$ 870.00	80
TF3012ST00	30" LETTER STARTER	\$ 450.00	50
TF3012AD00	30" LETTER ADDER	\$ 870.00	102
TF3015ST00	30" LEGAL STARTER	\$ 455.00	64
TF3015AD00	30" LEGAL ADDER	\$ 920.00	126
TF3018ST00	30" X-RAY/LATERAL FILE STARTER	\$ 460.00	76
TF3018AD00	30" X-RAY/LATERAL FILE ADDER	\$ 1000.00	140
TF3609ST00	36" VIDEO/BOOK STARTER	\$ 425.00	44
TF3609AD00	36" VIDEO/BOOK ADDER	\$ 870.00	93
TF3612ST00	36" LETTER STARTER	\$ 450.00	60
TF3612AD00	36" LETTER ADDER	\$ 870.00	122
TF3615ST00	36" LEGAL STARTER	\$ 455.00	76
TF3615AD00	36" LEGAL ADDER	\$ 920.00	141
TF3618ST00	36" X-RAY/LATERAL FILE STARTER	\$ 460.00	90
TF3618AD00	36" X-RAY/LATERAL FILE ADDER	\$ 1000.00	180
TF4209ST00	42" VIDEO/BOOK STARTER	\$ 445.00	50
TF4209AD00	42" VIDEO/BOOK ADDER	\$ 875.00	104
TF4212ST00	42" LETTER STARTER	\$ 475.00	68
TF4212AD00	42" LETTER ADDER	\$ 930.00	137
TF4215ST00	42" LEGAL STARTER	\$ 510.00	86
TF4215AD00	42" LEGAL ADDER	\$ 980.00	170
TF4218ST00	42" X-RAY/LATERAL STARTER	\$ 570.00	104
TF4218AD00	42" X-RAY/LATERAL ADDER	\$ 1000.00	203
TF4809ST00	48" VIDEO/BOOK STARTER	\$ 480.00	56
TF4809AD00	48" VIDEO/BOOK ADDER	\$ 885.00	115
TF4812ST00	48" LETTER STARTER	\$ 500.00	74
TF4812AD00	48" LETTER ADDER	\$ 975.00	150
TF4815ST00	48" LEGAL STARTER	\$ 550.00	94
TF4815AD00	48" LEGAL ADDER	\$ 1025.00	185
TF4818ST00	48" X-RAY/LATERAL STARTER	\$ 590.00	112
TF4818AD00	48" X-RAY/LATERAL ADDER	\$ 1040.00	220

*Aurora Shelving is not included in above pricing. To convert an existing Bi-File to a Tri-File, contact Customer Service.

AURORA SIDE-TO-SIDE CARRIAGE AND RAIL LAY-OUT EXAMPLES

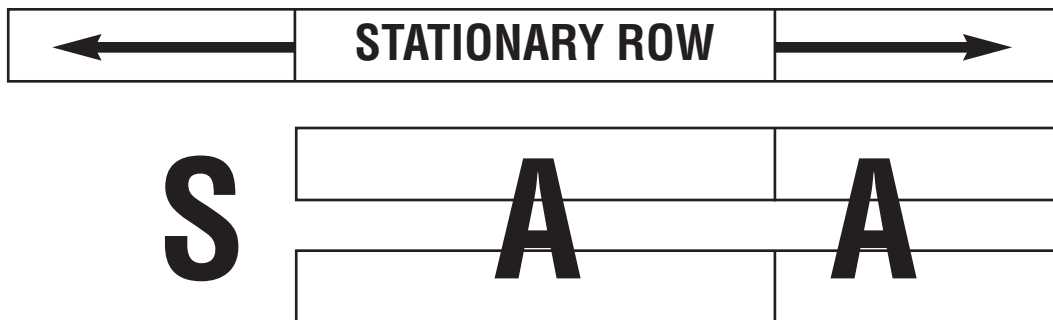
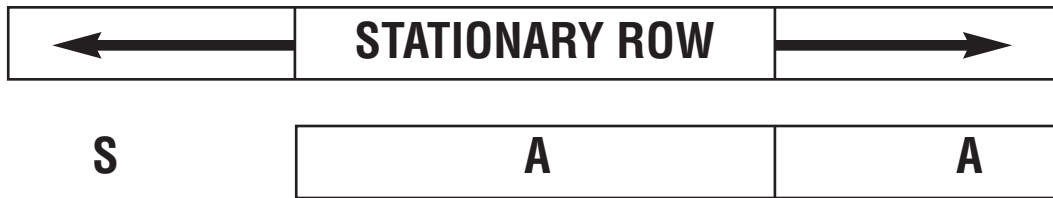

S = Starter
A = Adder

Richards-WILCOX

600 South Lake Street • Aurora, Illinois 60506
800-253-5668, ext. 4695 • Fax 630-897-6994
www.auroramobile.com